

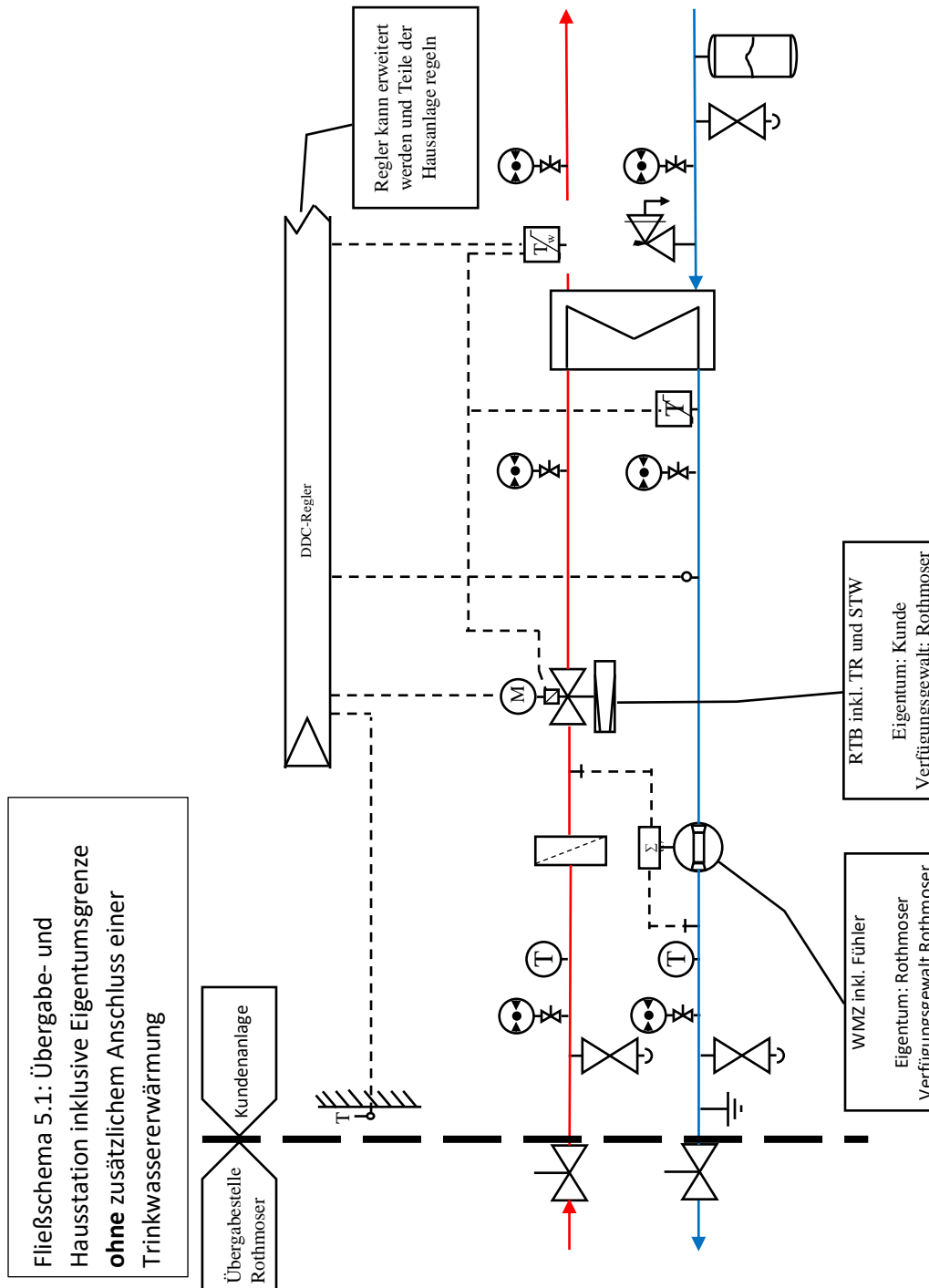

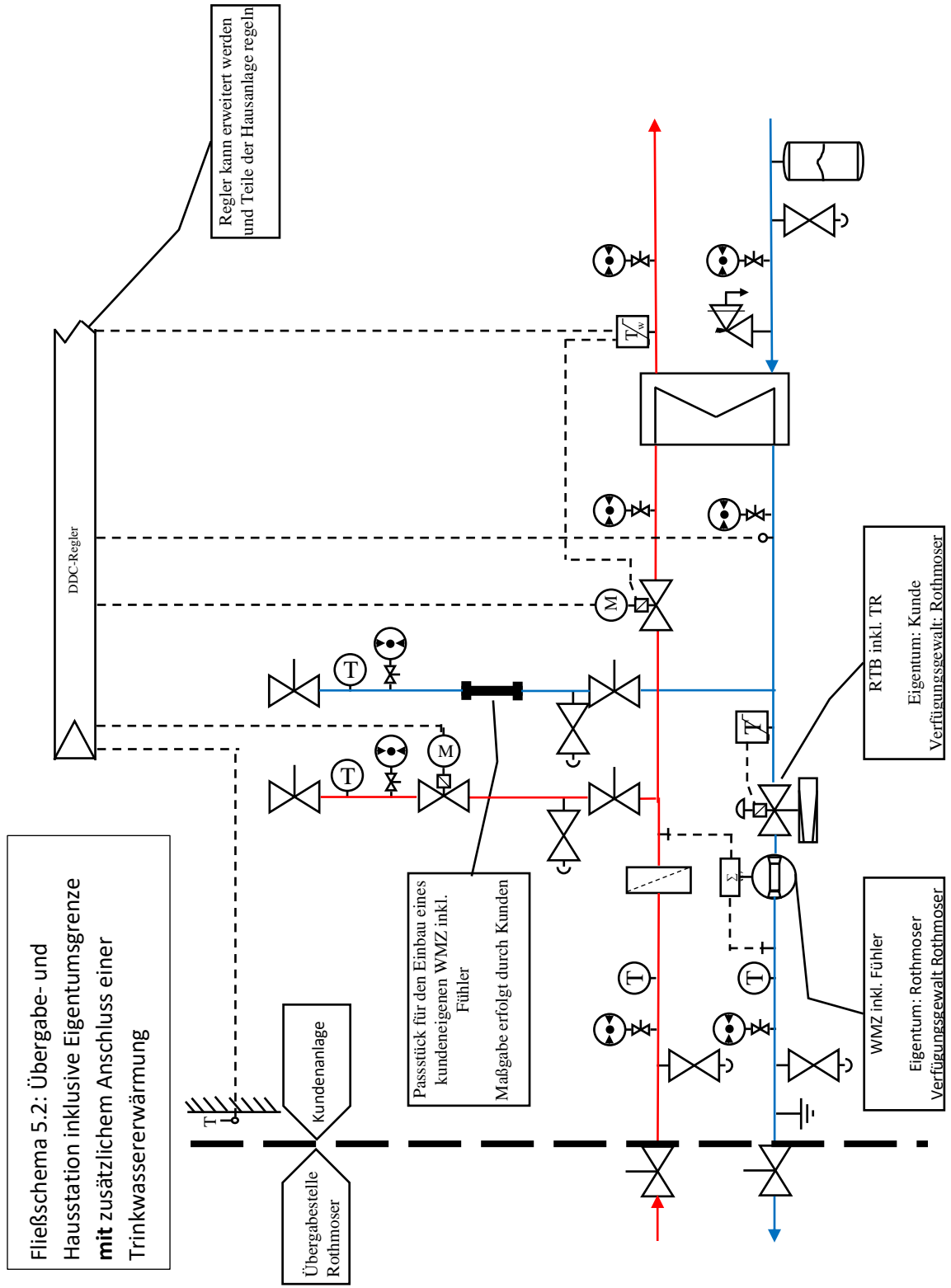











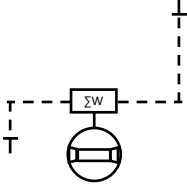
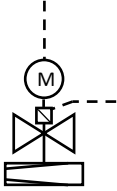
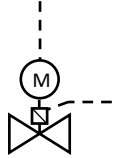
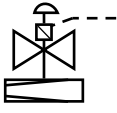

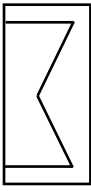
Anlage 5 zur TAB-HW der Rothmoser GmbH & Co. KG
 Zugelassene Fließschemen der Übergabestationen



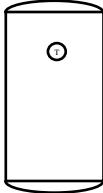
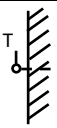

Fließschema 5.2: Übergabe- und Hausstation inklusive Eigentumsgrenze mit zusätzlichem Anschluss einer Trinkwassererwärmung

Legende zu Fließschemen		
Kennziffer	Bezeichnung	Symbol
1	Absperrarmatur	
2	Potentialausgleich	
3	Manometer	
4	Thermometer	
5	Schmutzfänger	
6	Wärmemengenzähler (WMZ) inklusive Vor- und Rücklauffühler	
9	Kombi-Motorventil mit Notstellfunktion, Volumenstrombegrenzer und Rücklauftemperaturbegrenzer (z.B. Danfoss AVQMT)	
10	Kombi-Motorventil mit Notstellfunktion (z.B. Danfoss AHQM oder AVQM)	
11	Ventil mit Volumenstrombegrenzer und Rücklauftemperaturbegrenzer (z.B. Danfoss AVQT)	
10	Temperaturregler TR	
11	TR und STW als Doppelthermostat	
12	Wärmeübertrager	
13	Sicherheitsventil	

14	Entleerungsventil	
15	Anschluss für Ausdehnungsgefäß	
16	Motor-Dreiwege-Regelventil	
17	Umwälzpumpe	
18	Wärmeverbraucher mit Heizflächen	
19	Heizwasserpufferspeicher oder Trinkwasserpufferspeicher und Zubehör	
20	Außentemperaturfühler	
21	Digitaler Heizungsregler	
22	Motor-Regelventil	